

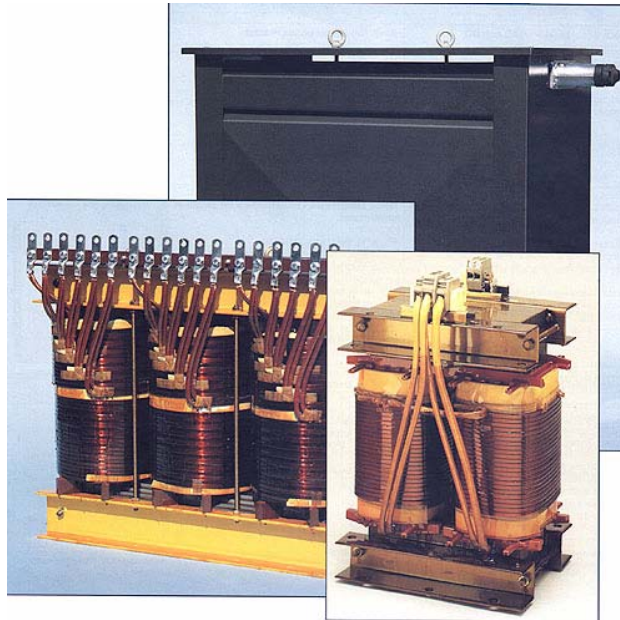

Muuntosähkö Oy - Trafox

Dry type Transformers



Working & Maintenance

Appendix

ITEM 1 – INTRODUCTION

- 1.1. Preface_____page 3
- 1.2. Applicable standards_____page 3
- 1.3. Construction_____page 3

ITEM 2 – INSTALLATION

- 2.1. Packaging and transport_____page 4
- 2.2. Lifting and Displacement of Transformers_____page 4
- 2.3. Installation_____page 5
- 2.4. Information about the protection devices _____page 6
- 2.5. Overload and working conditions_____page 8
- 2.6. Working temperatures_____page 8
- 2.7. Insulation distances_____page 9
- 2.8. Safety distances_____page 9
- 2.9. Overvoltage_____page 9
- 2.10. Mechanical fastenings and electrical connections_____page 10
- 2.11. Installation measurements for evacuation of heat produced by the transformer_page 10

ITEM 3 – STARTUP

- 3.1. Information_____page 11
- 3.2. Use_____page 11
- 3.3. Machine unloading inspections_____page 11
- 3.4. Visual inspections_____page 11
- 3.5. Mechanical and electrical controls before startup_____page 11

ITEM 4 – WORKING AND MAINTENANCE

- 4.1. General information_____page 13
- 4.2. Voltage change operations – if foreseen_____page 13
- 4.3. Transformer voltage adjustment_____page 13
- 4.4. Service and maintenance_____page 13
- 4.5. Warranty_____page 13

ITEM 1 – INTRODUCTION

1.1. Preface

This manual intends to supply all explanations needed in order to assure a correct use of our dry type transformers as well as the maintenance and control of them.

1.2. Applicable standards

- IEC 60076 – Standard Power Transformers
- IEC 61558 – Dry Power Transformers

1.3. Construction

This dry type transformer is normally produced according to standards mentioned above. Upon request transformers can be manufactured according to other standards (e.g. standards on ship transformers, isolation transformers for medical use and protection transformers. This should be agreed upon before ordering/manufacturing. The transformers are of temperature class F/155°C unless otherwise is agreed upon. The most important insulation materials (e.g. insulation of the coilwinding and impregnation enamel) are of temperature class H/180°C or C/220°C. This gives the construction excellent operating reliability and also good endurance of shorttime overload. Enclosed transformers are delivered to customers in IP-23 or IP-34 shielding enclosures. Other enclosures are available upon request.

ITEM 2 – INSTALLATION

2.1. Packaging and transport

Packaging must be done properly in order to assure a safe transportation without damages. According to the products dimensions different types of packing can be adapted. Wooden pallets are used for small transformers in order to facilitate the relevant loading and unloading. For large transformers polystyrene or cardboard is used to avoid eventual damages due to external agents. No matter how steady the transformers are packed, they cannot withstand violent shocks or excessive tugging of the lifting eyebolts. The transformers are protected on the outside with a shrinking polyethylene film which protects them from rain, dust or excessive dampness.



The transformers must be handled with care and stored in a dry space.

2.2. Lifting and displacement of transformers

When shipped from factory the transformers are always transported by truck, where as the buyer is responsible for unloading. A suitable length of strap must be used during unloading operations.

Figure 01, hereunder, clearly illustrates how height of B must be greater than A.

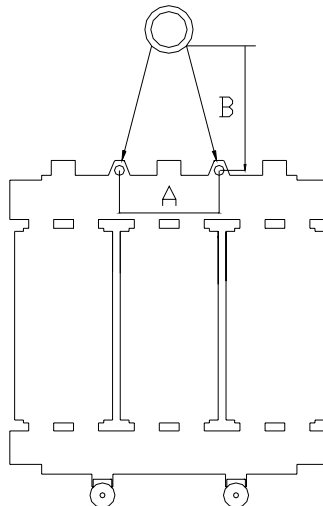

figure 01

The transformers are sometimes equipped with 90° revolving sliding wheels as illustrated in figure 02. (Special eye-bolts are provided near the wheels for moving the transformer.) Before startup, check that it has not been damaged during transport or storage.

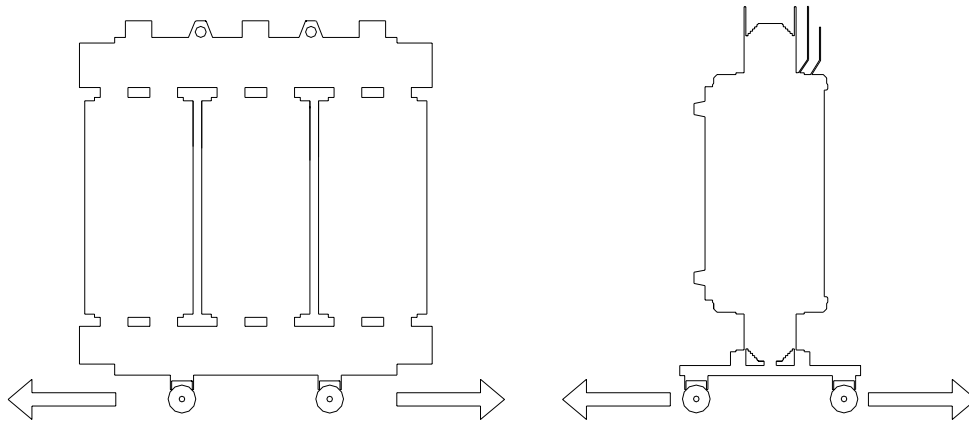

figure 02

Figure 03 hereunder shows exactly how to use the fork-lift truck without damaging the transformer.

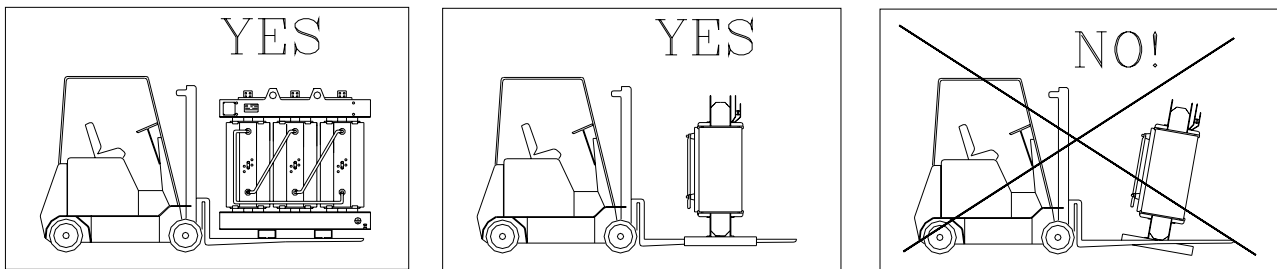



figure 03

	<p>Before lifting the transformer make sure that the lift forks are correctly inserted under the complete length of the transformer. If not, the balance of transformer can not be guaranteed and the transformer is likely to fall over.</p>
---	---

2.3. Installation

Transformers must be installed indoors in a dry airconditioned place. Only vertical installation is permitted. Floor mounting is recommended. Open construction transformers which are under 20kVA and low-profile can be installed vertical (cooling channels of winding upwards), if mounting plate is sufficiently sturdy. Approximately 100mm of free space must be left between wall and transformer enclosure so that cooling air may circulate. Temperature of the cooling air must not exceed 40°C. Otherwise a different way of cooling the installation place must be done. In case open construction transformer is installed in a closed enclosure is it recommended to have cooling air of 2.5m³/dissipation kVA/min.

Transformers are (depending on which rated power they have) equipped with copper rails, cable lugs or screw terminals to which copper cables according to nominal current can be connected. If aluminum cables and different size of copper cables are to be used, this must be notified when ordering. Transformer enclosure has lead-in preform for cables. Flanges and cable lugs of cables are not included in standard delivery.

2.4. Information about the protection devices

Temperature control is performed according to the diagram below. Three different types of control devices can be supplied as an option, allowing visual and audial inspection and the possibility for the device to trip. For normal application the trip temperature for the alarm is in accordance to applicable STANDARDS and are specifically indicated later in this handbook.

The devices illustrated are:

- Dial thermometer with two contacts;
- Electronic device with thermal contacts or PTC;
- Electronic device with control by PT100 sensors.

Thermometer with two electrical contacts (available as option)

This is the easiest way to monitor, control and measure the temperature on dry type transformers. The thermometer can be supplied with electrical contacts normally opened or normally closed as per wiring diagram figure 04. For recommended settings for alarm and trip see chapter 2.6. Max load 2,5A – 250V. This thermometer is extremely reliable.

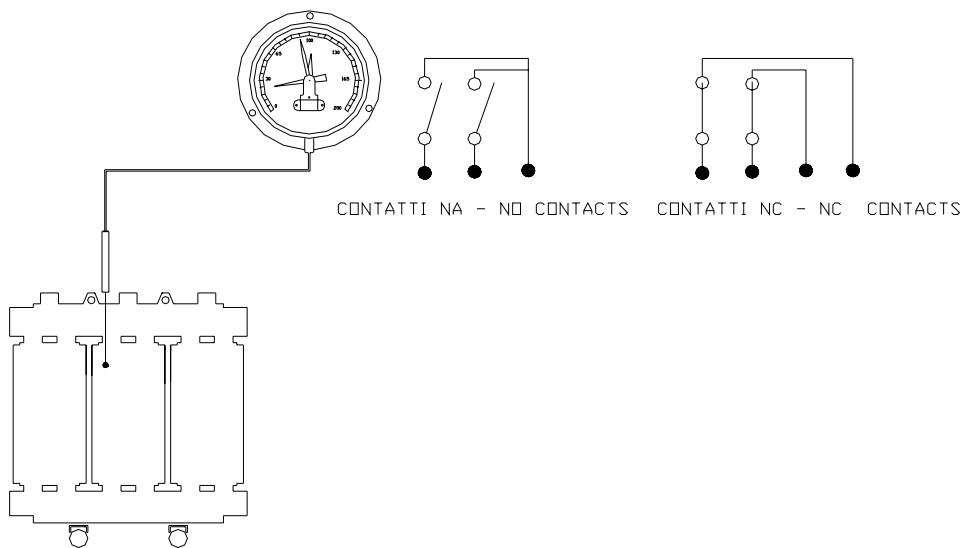

figure 04

2.5. Overload and working conditions

During special working conditions or special applications for which a temporary power increase is required, it is good to be familiar with all the essential features of the dry type transformer. The dry type transformer has a great thermal inertia and can endure large overloads for short time. Hereunder (figure 08) is indicated the state of the overloads in function of the time in minutes or hours.

Overload capacity and time according to the overload, the pre-load and an ambient temperature of 20° C

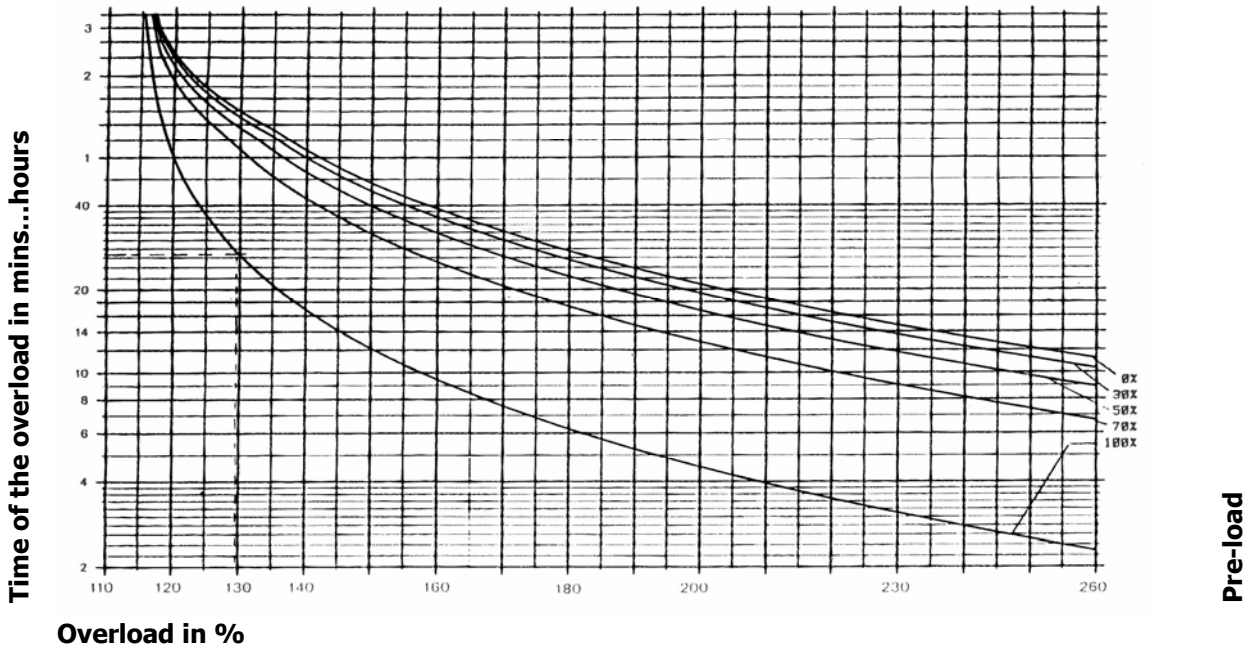

figure 08

2.6. Working temperatures

The working temperature of the transformers are changing according to the insulation class and the climatic class as per applicable standards and are indicated in the following table:

Table I

INSULATION CLASS	SERVICE RANGE C1 CLASS	SERVICE RANGE C2 CLASS
B	- 5 – +120 °C	-25 – +120 °C
F	- 5 – +140 °C	-25 – +140 °C
H	- 5 – +140 °C	-25 – +140 °C

Each transformer can be equipped with thermal contacts. Some devices have a sensor for each winding and a sensor in the core. For temperature control and supervision the provided temperature sensors shall be connected to the temperature device. The device normally has two levels for temperature settings. We recommend the following settings for alarm and trip:

Table II

INSULATION CLASS	ALARM	TRIP
B	120°C	130°C
F	140°C	150°C
H	160°C	170°C

2.7. Insulation distances

It is an absolute necessity to observe a minimum distance between the live parts of transformer, the surrounding metal masses and other elements of the device during working, according to applicable standards. The following table III shows the minimum insulation distances to respect:

Table III

MAX. INSULATION VOLTAGE (kV)	NOMINAL VOLTAGE AT SERVICE INDUSTRIAL FREQUENCY (kV)	NOMINAL VOLTAGE AT CREST VALUE ATMOSPHERICAL PULSES (kV)	AIR MINIMUM DISTANCE (mm)
3,6	10	20	60
		40	60
7,2	20	40	70
		60	90
12	28	60	90
		75	120
17,5	38	75	120
		95	160
24	50	95	160
		125	220
36	70	145	300
		170	360

2.8. Safety distances

The transformer must be placed and installed in such way that any risk of accidental contact between any person and the live parts is avoided and at the same time that evacuation of the produced heat is allowed and that the maximum winding temperature under the values indicated on the paragraph 2.6. is maintained. In order to avoid any accidental contact with the live parts, please observe the distances as indicated in the following table IV (according to applicable standards).

Table IV

MAX. INSULATION VOLTAGE (kV)	NOMINAL VOLTAGE AT SERVICE INDUSTRIAL FREQUENCY (kV)	NOMINAL VOLTAGE AT CREST VALUE ATMOSPHERICAL PULSES (kV)	SAFETY DISTANCE (mm)
3,6	10	20	150
		40	150
7,2	20	40	150
		60	150
12	28	60	150
		75	150
17,5	38	75	150
		95	200
24	50	95	200
		125	280
36	70	145	340
		170	400

2.9. Overvoltage

If there is any risk that the transformer could be exposed to overvoltage (due to atmospherical conditions or displacement) arrange protection by some gauged dischargers in connection with the needed insulation gauge.

2.10. Mechanical fastenings and electrical connections

All the external wirings – on the Low voltage side, on the High voltage side and in the earth points – must be properly performed and the insulation distances, the wires sections and positions must be taken into consideration. The locking and/or the gripping of electrical connections and of mechanical fastenings will be carried out according to the diagram hereunder (table V & table VI).

Table V

SCREWS	TIGHTENING TORQUE (Nm)*	
	Mechanical Connection	Electrical Connection
M 6	10	/
M 8	23	23
M 10	50	40
M 12	85	50
M 14	130	80
M 16	205	125

* Divide the values by 10 for kgm gauged dynamometrical keys.

For the bolts and screw-nuts auto-locked of the yoke pressure profiles, the torque has to be lower according the table hereunder:

Table VI

SCREWS	TIGHTENING TORQUE (Nm)* Mechanical Connection Yoke
M 8	8
M 10	9
M 12	11
M 14	17
M 16	21

* Valid for screws in steel (8,8 type). Divide the values by 10 for kgm gauged dynamometrical keys.

2.11. Installation measures for the evacuation of heat produced by the transformer

In order to assure a proper duration of the transformers, it is necessary to evacuate the heat that is produced in the magnetic circuit to avoid that the temperature limits are exceeded.

	<p>The cooling surfaces must be in contact with the circulating air through suitable intakes (approx 2,5 m³/min. per kW losses)</p>
---	---

	<p>The installation room must be properly ventilated. Arrange some barred openings on floor level for intake of fresh air and some openings in the opposite direction in relation to the longitudinal level of the transformer for outlet of the hot air.</p>
---	---

The ventilation will be more efficient as there is great difference H in height between the thermal axis of the transformer and the middle of the outlet opening.

ITEM 3 – STARTUP

3.1. Information

The transformer will be delivered without wheels or with the wheels not mounted.

3.2. Use

Transformers are dimensioned such, that they can be continuously loaded 100% by rated power under specified conditions (generally applicable IEC-standard). Nominal power is greatest allowed continuous power on power factor $\cos \varphi = 1$. All changes to voltage, voltage adjustment and outputs must be made in a off-circuit position.

3.3. Machine unloading inspections

Before unloading the machine it is extremely important to verify that the transformer not has been damaged during transport. Check, among other things, that the connections are not defective, the windings are not broken and that they are symmetric to the core axle.

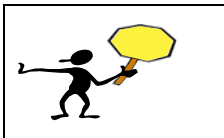

In case of damages or other problems, note the name of the carrier and describe the damage or problem on the carrier's papers and inform the retailer (Unitrafo Electric AB) as soon as possible. If these steps are not taken the carrier will not accept any liability for possible damages.

3.4. Visual inspections

Before startup it is necessary to verify that any foreign object has been left in the machine as it will cause serious damages during the setting up.

It is possible that during operations of installation and connection, or during storage, bolts, nuts, washers or other material coming from the surrounding equipments, gets caught in the winding channels.

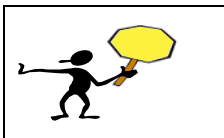

It is well advised after storing or stoppage, to clean the windings, eliminate dust, condensation and dirt by using dry compressed air or by using dry dust rags.

3.5. Mechanical and electrical controls before startup

Before startup, carry out an inspection in order to assure a proper installation and connection of the transformer.

The following points must be carefully examined:

- a) Clean the HV- and LV-windings and the relevant channels from dust and from dirt by the use of low pressure dried compressed air and dry dust rags.
- b) Preheat the transformer, in case of condensation, with a hot air fan or a similar device.
- c) Check the exact functioning of the probes. For this purpose it is enough to measure the resistance of the probes in centralization box of the transformer. The obtained value is converted to C-degrees by using the special conversion schedule. This should confirm the ambient temperature.
- d) Check the tightening of the connections and of the relevant outlet connections and of the adjustment plates.
- e) Check the bolts for connecting the transformer to the floor – if foreseen.
- f) Check that the windings are symmetric to the core axle.

- g)** Check that all connections are intended for the specific feeding voltage, see the data plate of the transformer.
- h)** Check all the protection devices of the transformer that protect against eventual overvoltages.
- i)** Check the positions of the bars on the terminal board. It must be the same as on the three HV-windings and must correspond with the specified feeding and loading voltages. In case the voltage exceeds the one allowed, the no load losses and the noise are increasing.
- j)** Check the circuits of the fans – if foreseen.
- k)** Check that it is possible to connect to earth at designated places on the transformer.
- l)** After the assembly is carried out, verify the connections and the adjustments of the auxiliary box, see the manual provided with this unit – if foreseen.
- m)** In case the transformer is working in parallel service with other units, the correspondence of phases must be checked by the use of a voltmeter. (Remember that, for the choice of voltmeter, in case of parallel mistake the voltage can be the double of the phase voltage and remember that nominal features shall be the same or compatible. Otherwise it will be impossible to make the parallel connection.)
- n)** Check that any metal parts as frame, wall or channels are placed at correct insulation distances as indicated in this manual.
- o)** It is strictly forbidden to place HV- and/or LV-voltage wiring, metal parts or any other things close to the windings. The windings are live parts. Wiring that is fitted too close to the windings or a Delta connection can cause serious damage to the transformer.
- p)** Check that bolts and nuts are securely tightened. This is important, especially if the transport has been characterized by continuous loading and unloading – for exact mechanical tightening see information included in this manual.
- q)** Check carefully that the windings not have been damaged during transport.
- r)** Check that the cooling duct of the windings for high and low voltage are free from packaging residues, such as nylon, paper, adhesive tape or cobwebs.
- s)** Check carefully that the cooling duct between the windings is symmetric.
- t)** In case of extreme non-symmetries in the duct C, contact the retailer.

ITEM 4 – WORKING AND MAINTENANCE

4.1. General information

A careful check of the machine during working allows you to obtain a prevention of defects and a more long duration of the material.

So the client can:

- perform most of the controls mentioned above, i.e. the ones considered suitable at time needed
- adjust and log the results of these controls
- arrange a maintenance and intervention program of the transformer to analyze and follow the machine over time

4.2. Voltage change operation - if foreseen -

Pay special attention when a change of voltage is required in the double primary voltage transformers. In this connection carefully read the information on the data plate or the wiring diagram included in the documentation.

	After change of voltage - whether a doubt exists - check through the test here under:
---	---

- Feed the primary voltage with a low available voltage on place.
- Use a manual tester - high precision is not required since the measure to perform is only a few volts.
- Calculate the ratio between the voltages and compare it with the required transformation ratio.

4.3. Transformer voltage adjustment

When necessary to adapt the transformation ratio to the feeding voltage proceed according to the following directions:

1. Disconnect the primary and secondary feedings (power off) and connect the transformer to earth.
2. Set the wiring plates or cable lugs in a suitable position. Tighten carefully according to torque described in 2.9, table V.
3. When ready, disconnect the earthing tools.
4. It is recommended that an insulation test is performed before the transformer is put back in charge.
5. Reconnect the primary and secondary feedings (power on).

4.4. Service and maintenance

Transformers do not require any service or maintenance in normal operational conditions. After introduction of transformer is it recommended to check tightness of connections in 3-12 months. If the installation place is dirty and dusty, the transformer should be cleaned by dusting, air pressure cleaning or other suitable method regularly. Cleaning of the transformer as described above is also recommended before taken in commission if it has been stored for a longer period.

4.5. Warranty

All the machines are guaranteed for the period time according to agreement.

	The warranty is limited to machine replacement or reparation in our factory in Helsinki, Finland, transports excluded. All type of damages due to breakdowns are excluded.
---	---